

Provide a full range of environmental system  
equipment and services  
for industrial and commercial customers, urban  
cleaning, etc

## N6 Double Brush Drive Floor Scrubber

### Operating instruction manual



旌旗环境科技（浙江）有限公司

Pennon Environmental Technology (Zhejiang) CO., Ltd

Address : 318 Xinghe Road, Yuyue Town, Deqing County, Huzhou  
City, Zhejiang Province, China

Tel : 4001-070-169

Website : [www.pennonenv.com](http://www.pennonenv.com)

旌旗环境科技（浙江）有限公司

Pennon Environmental Technology (Zhejiang) CO., Ltd

## Please read this manual carefully before use

This manual provides necessary machine operation and maintenance instructions. Before operating or using this machine, please read and understand this manual carefully. When ordering replacement parts, please refer to the spare parts manual that comes with the machine.

Before selecting parts or accessories, please confirm your machine model and serial number. You can order parts or accessories from manufacturers or distributors by phone or mail. This machine can provide excellent service. If we can further achieve the following points, we will be able to achieve the best results at the lowest cost:

Handle the machine carefully

Regularly maintain the machine according to the maintenance instructions provided in the operating manual.

Repair using parts or grades manufactured by the original manufacturer.

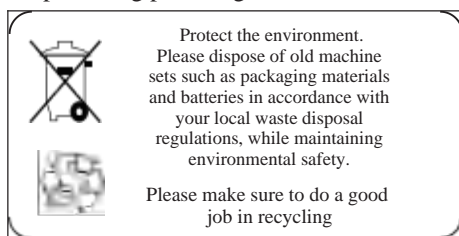

Address : No.318 Xinghe Road, Yuyue Town, Deqing

County, Huzhou City, Zhejiang Province, China

TEL : 4001-070-169

Website : <http://www.pennonenv.com/>

Specifications and parts are subject to modification without prior notice.

Machine information:

Machine model:

Machine serial number:

Machine options:

Sales representative:

Sales representative phone number:

Customer ID:

Sales date:

## CONTENTS

1.Attention.....	3
2.Operation Instructions.....	5
3.Receiving Machine.....	6
4.Machine cleaning method.....	7
5.Machine operation.....	8
6.Install the battery.....	9
7.Machine maintenance.....	10
8.Attention to the handling machine.....	11
9.Troubleshooting.....	12
10.Technical parameters.....	13
11.Machine size.....	14

# 1、 Attention

This machine is suitable for industrial and commercial use, specifically for cleaning hard indoor floors, and is not used for other purposes. Please use all recommended cleaning pads and brushes, as well as commercially available floor cleaners suitable for this machine.

The following is an explanation of the safety warning symbols and safety concerns used in this manual

 **WARNING: Used to warn of risks or unsafe operations that may cause serious personal injury or death.**

For safety reasons: point out the precautions that must be followed during the use of this machine to ensure safety.

If the following warnings are not followed: it may cause personal injury, electric shock, fire or explosion.

 **WARNING: Fire or explosion hazards:**

1: Do not use flammable liquids and do not operate the machine near or in areas with flammable liquids, gases, or dust.

2: This machine is not equipped with an explosion-proof motor. If using this machine in a place with flammable gases, liquids, or combustible dust, it can be

During start-up and operation, the electric motor will generate sparks, which may cause flickering or explosion.

3: Do not pick up flammable materials or active metals.

4: The battery releases hydrogen gas. Please stay away from sparks or open sources of ignition, and ensure that the battery compartment is open when charging.

 **WARNING: Electric shock hazard, please disconnect the battery connection wire before repairing the machine.**

 **WARNING: Rotating brush operation, please do not approach with both hands, please turn off the power before repairing the machine**

The following information indicates situations that may pose potential hazards to operators or equipment:

For safety reasons:

1: Do not operate the machine:

① Remove flammable liquids or close to flammable gases, otherwise it may cause explosions or flash fires.

② Unless trained, understand the operation manual.

2: Before starting the machine:

① Please ensure that all security settings are located and operated correctly.

3: When using the machine:

① When encountering slopes and slippery surfaces, please walk slowly.

② Wear non slip shoes.

③ Please slow down when turning.

④ Machine damage or operational failure should be reported immediately.

⑤ Do not let children play on the machine.

⑥ Follow the mixing ratio and handling instructions on the chemical container.

4: When leaving or repairing the machine:

① Park the machine on a stable surface.

② Turn off the power.

5: When repairing the machine:

① Avoid moving parts and do not wear loose tops, shirts, or sleeves.

② Before operating the machine, please disconnect the battery wiring.

③ When handling batteries or battery wiring, please wear protective gloves and eye protection equipment.

④ Avoid contact with battery liquid acid.

⑤ Please do not use high-pressure spraying or water pipes to flush this machine.

⑥ Use replacement parts provided or approved by the manufacturer.

⑦ All repairs must be carried out by qualified maintenance personnel.

⑧ Please do not modify the original design of the machine.

6: When handling machines:

① Please turn off the power.

② Do not move the machine with batteries installed.

③ Please handle the machine with the assistance of others

④ When loading and unloading machines from trucks or trailers, please use the recommended loading and unloading level.

⑤ Use ropes to secure the machine to a truck or trailer.

⑥ Lower the brush head to the lowered position.

## 2、 Operation Instructions

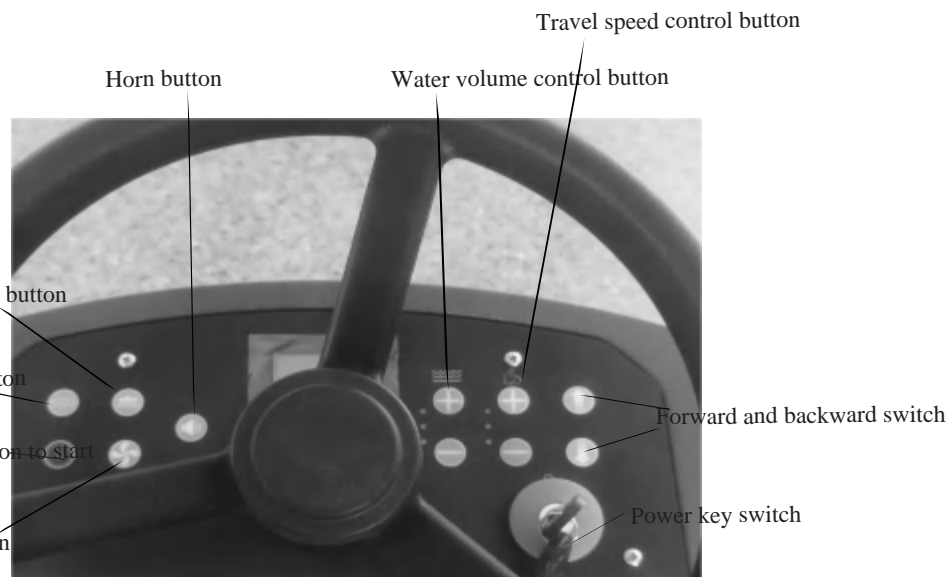

## 3、 Receiving Machine

### Unpacking the machine

1: Check the list of goods. If there are any omissions, please contact the seller.

- Two 12V batteries - standard configuration
- One 24V battery charger- standard
- A set of battery connecting wires - standard configuration
- 2 floor brushes-standard configuration
- 2 Pad Driver s- standard configuration
- Other accessories -purchaseseparately

2: To open the machine package, please first remove the shipping fasteners and ropes that secure the machine to the warehouse. With the assistance of others, carefully unload the machine from the warehouse.

Attention: If the loading and unloading platform is not used, do not directly push the machine to avoid damage.

Attention: To avoid damage to the machine, please remove it from the warehouse before installing the battery.

### Installing the battery:

**⚠ WARNING: Fire or explosion hazard, hydrogen gas is released from the battery. Please stay away from sparks or open sources of ignition. The battery cap must be kept open when charging.**

For safety reasons: When repairing the machine, please wear protective gloves and eye protection equipment when handling batteries and battery wiring. Avoid contact with battery liquid acid.

Park the machine on a level surface and remove the key.

Lift the sewage tank to expose the battery compartment.

Carefully install the battery inside the battery compartment door and connect the battery cable as shown in the diagram below.

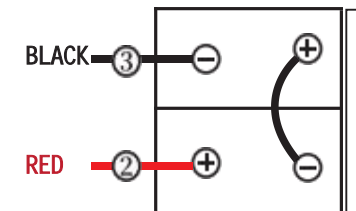

Attention: Do not throw the battery into the battery compartment to avoid damage to the battery and machine.

4. Before connecting the battery, please make sure that the electrodes and terminals are clean. Use electrode cleaning solution and wire brush as needed. Note: Apply a thin layer of metal free lubricating oil or protective spray on the connected wiring to avoid battery corrosion. After installing the battery, please check the power scale on the battery meter and charge the battery as needed.

## 4、 Machine cleaning method

Cleaning method: Manually control the water valve to adjust the amount of cleaning solution (water and cleaning agent) flowing to the ground. The brush uses a solution mixed with cleaning agent and water to clean the floor. While the machine is moving forward, it uses a suction scraper to suck the sewage on the floor into the sewage tank.

### Brush and Pad Information

To ensure optimal efficiency, please use the brush type correctly for cleaning work.

Suggested use of brushes and scouring pads as follows: 1. Soft nylon brush (white)

Suggested for cleaning coated flooring without damaging the floor, cleaning without leaving scratches.

2. White scouring pad polishing pad (also known as polishing pad)

Used to maintain highly shiny or polished floors.

3. Red scouring pad polishing pad (also known as buffer pad)

Used to scrub minor dirt without damaging the ground.

4. Black scouring pad polishing pad (also known as gravity folding pad)

Used for strong removal of heavy coatings or substrates, or for ultra strong scrubbing.

## 5、 Machine Installation

Install and connect water suction rake assembly

Park the machine on a level ground and take out the key.

Press the suction motor button.

When installing the water suction pick-up to the water suction pick-up installation bracket, make sure that the fastening knob is completely placed in the jack before tightening the knob.

Connect the vacuum suction pipe to the suction pick assembly.

Check the absorbent strip and adjust it properly.

Install Brush/pad

Park the machine on a level ground.

Press the brush disc switch button to lift the brush head off the ground.

First place the cleaning pad on the needle seat, and then install the water bar. Fasten the center lock to fasten the cleaning pad.

Align the pin holder/brush mounting pin into the motor drive disc snap and press the brush disc motor switch.

To remove the needle holder and brush, press the brush disc switch button to lift the brush head off the ground, and press the brush disc motor switch.

## 6、 Machine operation

For safety reasons: Do not operate the machine until you have read and understood the operating manual.



**WARNING: Fire or explosion hazard. Do not operate the machine near or in areas with flammable liquids, gases, or dust**

### 1. Pre operation inspection

Clean the dust on the ground.

Check the power scale of the battery meter.

Check the wear of the brush head skirt and the wear of the cleaning pad/brush. Check the wear of the water absorbing adhesive strip and adjust the angle appropriately.

Ensure that the sewage tank is empty and that a clean floating filter screen has been installed.

### 2. Operating the machine

Press and rotate the main power key.

Press the water suction motor button to lower the water suction skid assembly to the ground.

Press the brush disc switch button to lower the brush head to the ground.

Turn on the forward and backward switch.

Press the water volume adjustment button to adjust the water volume.

Press the speed control button: adjust the speed control knob to the cleaning speed you want.

Note: the recommended cleaning rate is 40-60 meters per minute.

During operation of the machine



**Warning: Danger of fire or explosion. Do not pick up flammable materials or reactive metals.**

Each cleaning path overlaps by 5 cm.

Keep the machine moving so as not to damage the ground.

If absorb water pick up after absorbing water, the ground has drag mark, wipe with dishcloth try glue strip to remove rubbish. Sweep in advance to prevent drag marks.

For safety: when using the machine, move slowly on slopes and slippery surfaces.

If there is too much foam, pour the recommended defoamer solution into the sewage tank.

Note: Do not let foam into the filter screen to avoid damage to the vacuum motor. The foam will make the filter switch inoperable.

Use dual cleaning to clean extremely dirty areas. First water pick up for cleaning, let the solution impregnated for 3-5 minutes, the water pick down and clean again.

Change or rotate the cleaning pad as needed.

Observe the amount of electricity used by the battery meter (refer to “ Battery meter” ).

Check the remaining liquid through the clear water tank level gauge. About 10 liters are used every 10 minutes in the traditional way.

When the solution in the clear water tank is used up, empty the sewage tank first and then re-inject the solution.

When the worker leaves the machine, please park the machine on the level ground and take out the key.

## 7、 Battery meter

The battery meter will show the battery charge. When the battery is fully charged, all the lights come on. As the power is used up, the lights will go off from right to left.

To extend battery life, do not let the indicator light off below the following power consumption.

Note: In order to prolong battery life, please be sure to use the machine after the total number of hours more than 30 minutes before charging the battery.

## 8、 Drain the water tank

Clean water tanks should be cleaned regularly to remove any corrosion. Place, turn off the power key and drain in accordance with the following discharge instructions: for safety reasons: before leaving or repairing the machine, please park the machine on the level ground and turn off the machine and take out the key. Discharge the sewage tank

Unscrew the drain cover of the sewage tank counterclockwise and remove it.

Open the cover of the sewage tank and then flush the tank.

Remove and flush the floating filter in the tank.

## 9、 Charge the battery

Note: In order to extend battery life and ensure the best performance of the machine, the machine must be used at least more than 30 minutes before the battery charge. Do not leave the battery uncharged for a long time. The following charging instructions apply to the charger attached to this machine. Please be sure to use the following specifications of the Charger, in order to avoid battery damage.

Battery Charger specifications:

- Type of charger: -Charger for lead-acid batteries
- output voltage-24 volts
- output current-20 amperes
- automatic circuit breaker
- suitable for deep cycle battery charging

Move the machine to a well-ventilated place for charging.

 Warning: Danger of fire or explosion. The battery releases hydrogen gas. Stay away from sparks or open fires. Keep battery compartment open during charging.

Park the machine on a level surface and turn the key to the closed position.

Check the electrolyte level in each battery unit before charging.

For safety's sake: please wear protective gloves and eye protection equipment when handling battery and battery wiring when repairing the machine. Avoid contact with battery acid.

When charging, please turn the sewage tank to the side for ventilation.

Plug the Charger's AC power cord into a well-grounded power outlet.

Insert the Charger DC Line into the battery charging outlet behind the sewage tank.

The charger will automatically start charging and will automatically turn off when it is full.

Description: The Machine will not be able to operate when connected to the charger. Note:

Do not unplug the Charger DC cable from the socket on the machine during charging. Avoid arc discharge. If you must stop charging on the way, please unplug the AC Power Cord first.

 Warning: Danger of fire or explosion. The battery releases hydrogen gas. Stay away from sparks or open fires. Keep battery compartment open during charging.

After charging, check the electrolyte level again.

## 10、 Machine maintenance

As long as daily, weekly and monthly maintenance procedures are followed, the machine can be kept in optimal working condition. Warning: Danger of electric shock. Disconnect the battery before servicing the machine.

Daily Maintenance (after each use)

Drain and clean the sewage tank.

Remove and flush the floating filter screen in the sewage tank.

Drain the clear water tank and flush the tank with hot water up to 60 ° C as necessary

Remove cleaning pads/brushes for cleaning. In case of wear and tear, turn over or replace the cleaning pad.

Wipe the absorbent strip. Place the water-absorbing skid assembly in the lifting position to prevent the adhesive strip from being damaged.

Check the water suction strip scraper edge wear condition. If there is wear and tear, the two ends of the tape switch.

Use a multi-purpose cleaner and a damp cloth to clean the machine. For safety's sake: when cleaning the machine, please do not use high-pressure spraying or water hoses to flush the machine. To avoid causing failure of electronic components.

Check the wear condition of brush head skirt, if there is wear or damage to replace.

Charge the battery. In order to extend the battery life and ensure the best performance of the machine, the machine must be used more than 30 minutes before the battery charge.

Monthly Maintenance (80 hours per use)

Remove the tank filter from under the machine and clean the screen. Be sure to empty the tank before removing the filter.

Clean battery top to prevent electrode corrosion.

Check the battery connection for looseness.

Check and clean the seal of the sewage tank cover. Replace if damaged.

Spray dry silicone lubricant on all pivots and rollers and cover them with a waterproof lubricant to keep the axles running smoothly.

Check for loose nuts and bolts on the machine.

Check the machine for leaks.

Quarterly maintenance

Every 250 hours to check the drive motor (drive model) , vacuum motor and brush motor carbon brush wear. When the length of the carbon brush wear less than 10 mm, need to change the carbon brush. Please contact the authorized service center if the machine needs to be repaired.Carrying machines



Warning: danger of electric shock. Please disconnect the battery before repairing the machine.

## 11、 Carrying machines

When using trucks or trailers to move machinery, be sure to follow the following binding procedures:

Raise brush head to handling position.

Use the proposed loading dock loading machine.

Place the front of the machine against the front of the truck or trailer. Once the machine is in place, lower the brush head and turn the key to the closed position.

Put obstacles behind each drive wheel to prevent the machine from sliding.

Use a rope to secure the top of the machine to prevent tilting. You must install brackets on the boards of your truck or trailer. For safety: when handling machinery, please use the suggested loading dock to load and unload the machinery from a truck or trailer and attach it to the board by ropes.

Storage Machine :

Please charge the battery before storing. Storage should not be carried out when the power supply is exhausted.

Drain and rinse the tank thoroughly.

Store the machine in a dry place, and the brush head should be kept in the lifting position.

Open the cover of the sewage tank for ventilation. Caution: Keep the machine away from rain and store it indoors.

If storing the machine in a cold environment, be sure to drain all fluids from the inside of the machine.

Problem	Reason	Solutions
The machine is inoperable	The battery is dead	Charge the battery
	Battery failure	Replace the battery
	The battery connection is loose	Tighten the battery connection
	The main fuse blew	Replace the fuse
The brush motor does not work	Brush head up off the ground	Lower Brush Head
	Battery meter lock not started	Charge the battery
	Brush disc motor circuit breaker triggers trip	Reset brush circuit breaker button
	Brush (up/down ) switch failure	Please contact the service centre
	Carbon Brush wear motor	Please contact the service centre
The vacuum motor does not work	Suction lifts off the ground	Drop the suction grate
	The vacuum motor fuse blew out	Replace the fuse
	Vacuum motor or wiring failure	Please contact the service centre
	Carbon Brush wear motor	Please contact the service centre
Run off with little or no water	Water tank filter or solution pipe is blocked	Clean the water tank filter
	The flow control knob is set too low	Adjust the water flow control knob
	Loosen the screws on the control knob	Lubricate the knob and tighten the screw
The efficiency of sewage recovery is low	The sewage tank is full	Drain the sewage tank
	Water-absorbent tape wear	Replace the absorbent tape
	The suction pipe is blocked	Remove clogged debris
	Damaged seal of sewage tank	Replace the seal
	Vacuum motor failure	Please contact the service centre
Reduced running time	The battery is defective	Replace the battery
	Battery charging failure	Repair or replace the charger

# Double Brush Drive Floor Scrubber Pennon N6 Technical parameters

Technical parameters	UNIT	Pennon-N6
Working width	mm	700
Width of suction strip	mm	1000
Brush Motor	W	300x2
Front drive motor	W	650
Suction motor	W	500
Clear water tank	L	80
Sewage tanks	L	90
Batteries	Ah/v	120/24
Cleaning efficiency	m <sup>2</sup> /h	4000
Voltage	V	24
Weight	kg	260
Length x width x height	mm	1300x1000x1220

## Pennon N6 Size Map

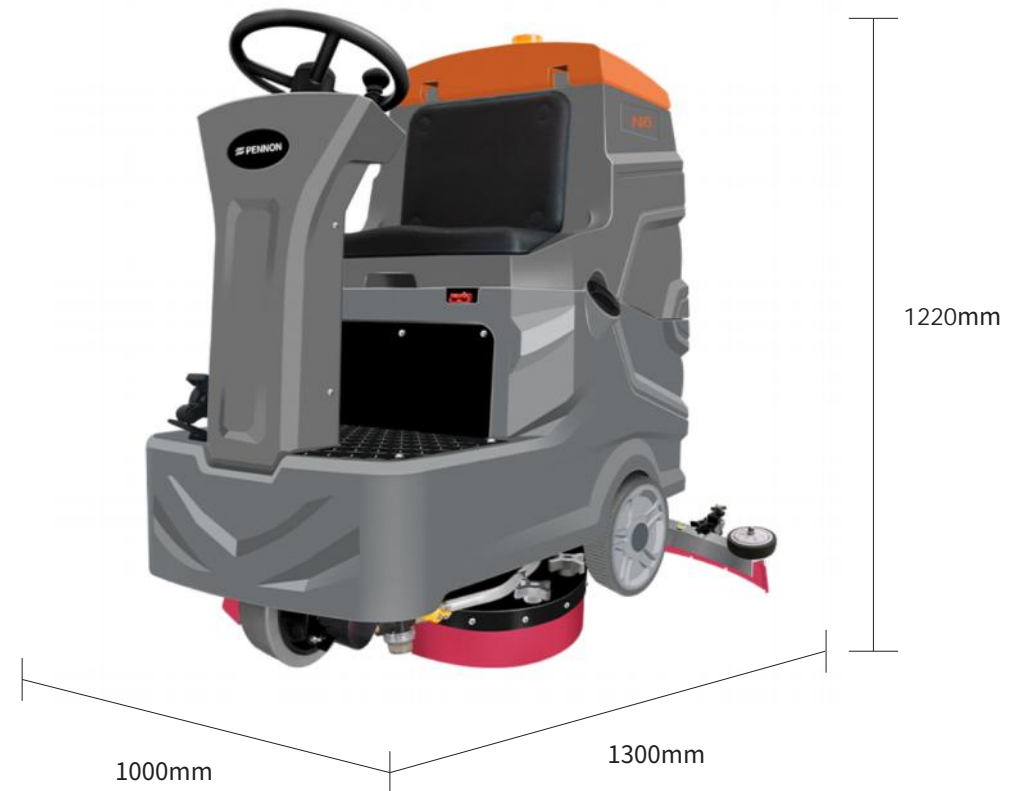

## About machine warranty instructions

ONE year warranty for the entire machine, excluding vulnerable and consumable parts (solenoid valve, power switch, suction pipe, sewage pipe, rubber strip, brush disc, needle disc, universal wheel of the machine body, scraper guide wheel, cleaning pad, fuse, suction scraper anti-collision wheel)

ONE year limited warranty period

Within one year from the date of purchase, for any components and electronic components found to have defects in materials and performance during sales inspections by our company, after checked by our technology team, if it is caused by quality problem, we will choose to repair or replace them free of charge for the original purchaser.

Exclusions from warranty

Without the prior explicit consent of our company, repairing or modifying any component of the floor scrubber without authorization is not covered by our company's warranty liability. Any damage caused by leakage, abuse, misuse, accident or negligence, incorrect operation, maintenance or storage of battery liquid, or other abnormal use is not within our company's scope of responsibility. Our company will not bear any labor, business call, transportation or other expenses incurred for repairing this product.

There is no other clear warranty

Warranty is limited to one year, starting from the date of purchase, and within the scope permitted by law.